

FORMA

Flashings

Box 1690, Fort Macleod, Alberta T0L-0Z0
Fax (403) 553-3896

Ph. (403) 553-3309

COMPLETE LINE OF STEEL SIDING AND ROOFING

STEEL Ltd.

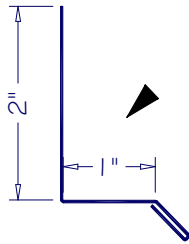

BASE
BF-01

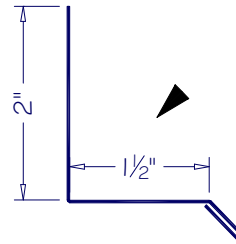

BASE
BF-02

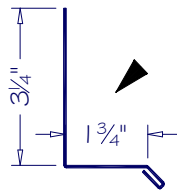

BASE
BF-03

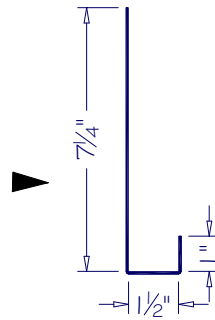

DOOR JAMB
DJ-01

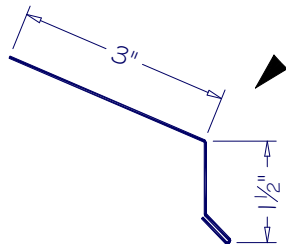

EAVE
EV-01

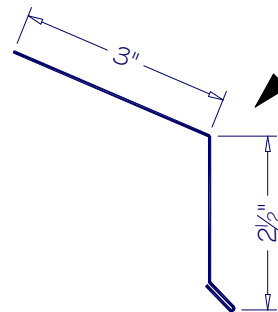

EAVE
EV-02

FORMA

Flashings

Box 1690, Fort Macleod, Alberta T0L-0Z0
Fax (403) 553-3896

Ph. (403) 553-3309

COMPLETE LINE OF STEEL SIDING AND ROOFING

STEEL Ltd.

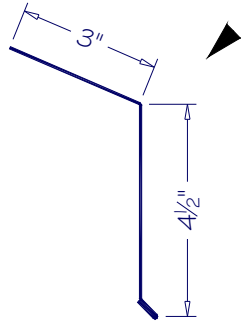

EAVE
EV-03

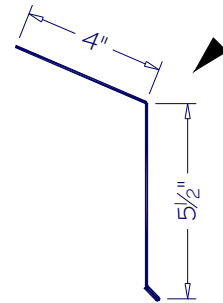

EAVE
EV-04

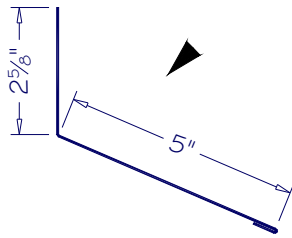

END WALL
EW-01

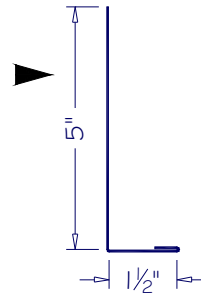

FASCIA
FC-01

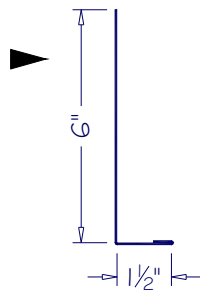

FASCIA
FC-02

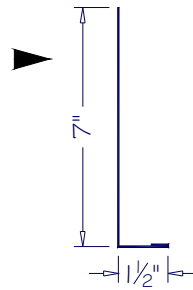

FASCIA
FC-03

FORMA

Flashings

Box 1690, Fort Macleod, Alberta T0L-0Z0
Fax (403) 553-3896

Ph. (403) 553-3309

COMPLETE LINE OF STEEL SIDING AND ROOFING

STEEL

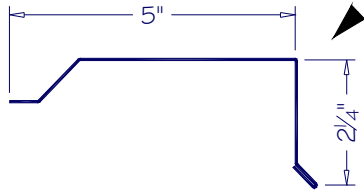
 Ltd.

GABLE
GB-01

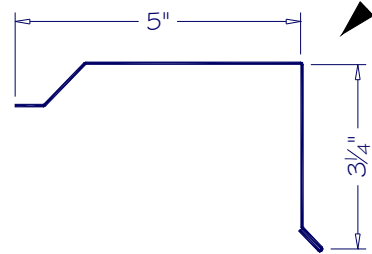

GABLE
GB-02

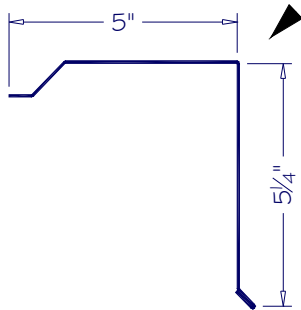

GABLE
GB-03

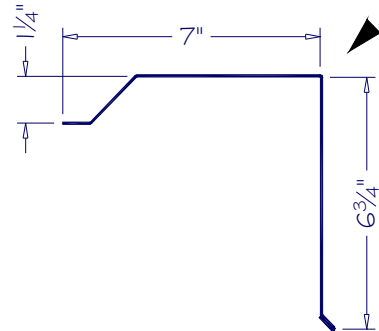

GABLE
GB-04

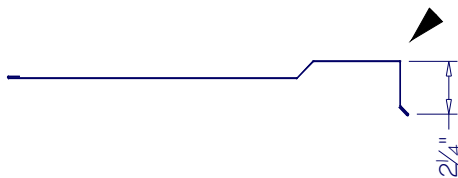

PROW GABLE
GB-P1

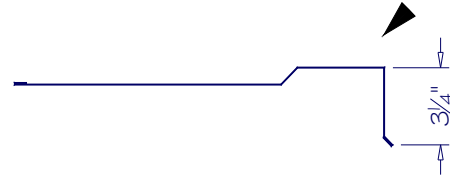

PROW GABLE
GB-P2

FORMA

Flashings

Box 1690, Fort Macleod, Alberta T0L-0Z0

Fax (403) 553-3896

Ph. (403) 553-3309

COMPLETE LINE OF STEEL SIDING AND ROOFING

STEEL Ltd.

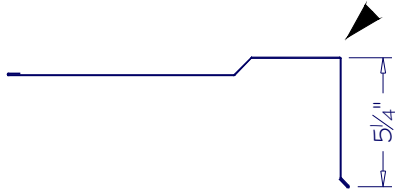

PROW GABLE
GB-P3

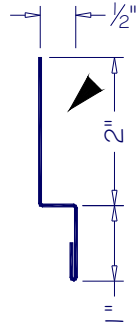

GABLE DIVIDER
GD-01

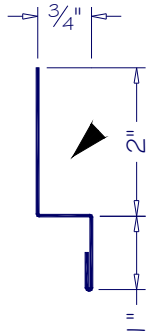

GABLE DIVIDER
GD-02

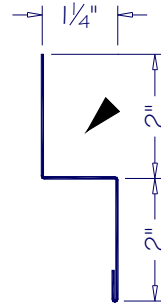

GABLE DIVIDER
GB-03

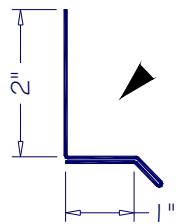

HEADER
HD-01

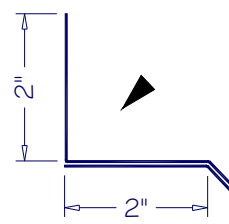

HEADER
HD-02

FORMA

Flashings

Box 1690, Fort Macleod, Alberta T0L-0Z0
Fax (403) 553-3896

Ph. (403) 553-3309

COMPLETE LINE OF STEEL SIDING AND ROOFING

STEEL Ltd.

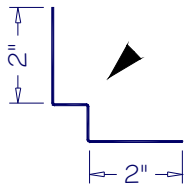

INSIDE CORNER
ISC-01

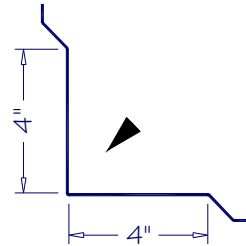

INSIDE CORNER
ISC-02

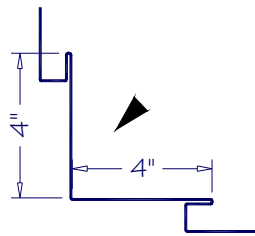

INSIDE CORNER
ISC-03

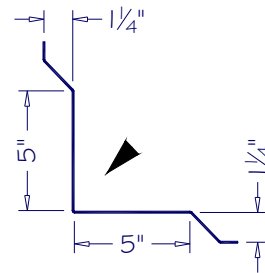

INSIDE CORNER
ISC-05

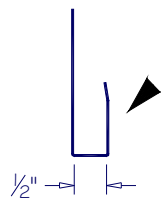

J CHANNEL
J-01

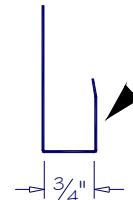

J CHANNEL
J-02

FORMA

Flashings

Box 1690, Fort Macleod, Alberta T0L-0Z0
Fax (403) 553-3896

Ph. (403) 553-3309

COMPLETE LINE OF STEEL SIDING AND ROOFING

STEEL Ltd.

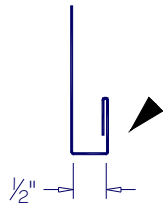

J CHANNEL
J-03

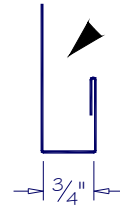

J CHANNEL
J-04

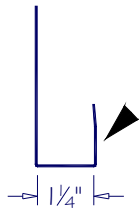

J CHANNEL
J-05

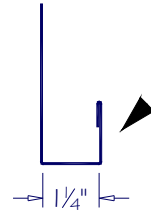

J CHANNEL
J-06

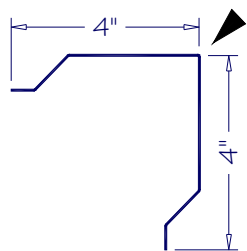

OUTSIDE CORNER
OSC-01

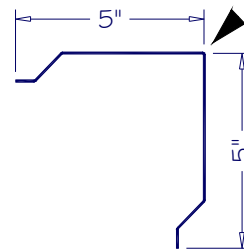

OUTSIDE CORNER
OSC-02

FORMA

Flashings

Box 1690, Fort Macleod, Alberta T0L-0Z0
Fax (403) 553-3896

Ph. (403) 553-3309

COMPLETE LINE OF STEEL SIDING AND ROOFING

STEEL Ltd.

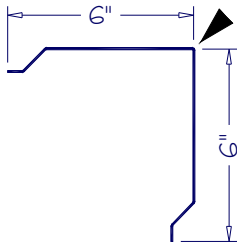

OUTSIDE CORNER
OSC-03

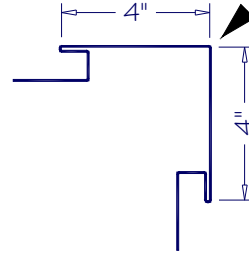

OUTSIDE CORNER
OSC-04

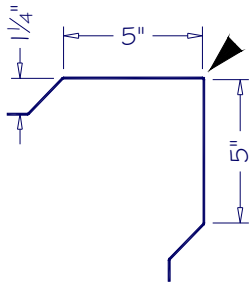

OUTSIDE CORNER
OSC-05

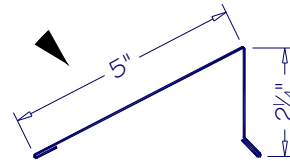

PEAK CAP
PC-01

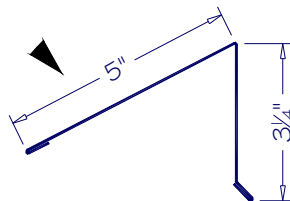

PEAK CAP
PC-02

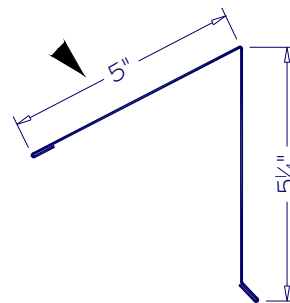

PEAK CAP
PC-03

FORMA

Flashings

Box 1690, Fort Macleod, Alberta T0L-0Z0
Fax (403) 553-3896

Ph. (403) 553-3309

COMPLETE LINE OF STEEL SIDING AND ROOFING

STEEL Ltd.

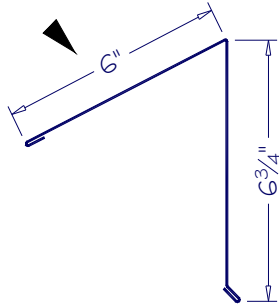

PEAK CAP
PC-04

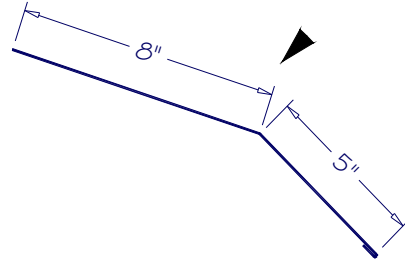

PITCH TRANSITION
PT-01

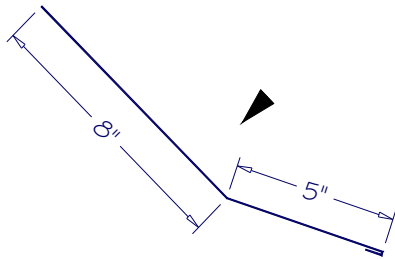

PITCH TRANSITION
PT-02

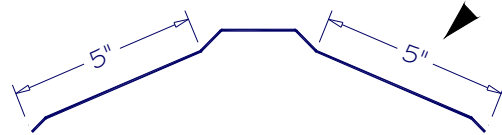

RIDGE CAP
RC-01

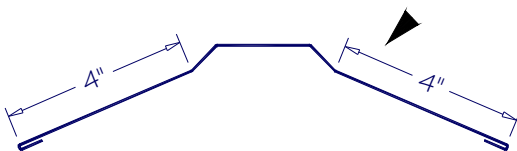

RIDGE CAP
RC-02

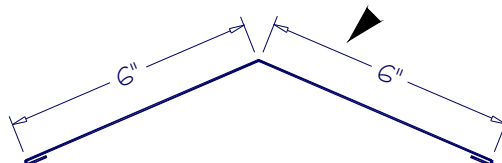

RIDGE CAP
RC-03

FORMA

Flashings

Box 1690, Fort Macleod, Alberta T0L-0Z0

Fax (403) 553-3896

Ph. (403) 553-3309

COMPLETE LINE OF STEEL SIDING AND ROOFING

STEEL Ltd.

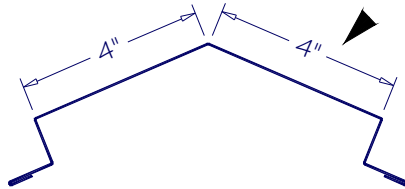

RIDGE CAP
RC-04

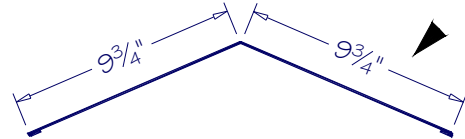

RIDGE CAP
RC-A

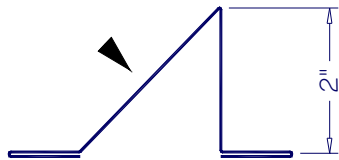

SNOW STOP
SS-01

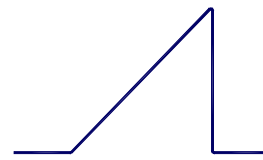

SNOW STOP LINER
SS-L

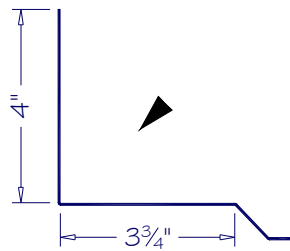

SIDE WALL
SW-01

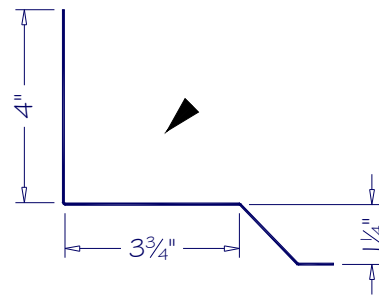

SIDE WALL
SW-02

FORMA

Flashings

Box 1690, Fort Macleod, Alberta T0L-0Z0

Fax (403) 553-3896

Ph. (403) 553-3309

COMPLETE LINE OF STEEL SIDING AND ROOFING

STEEL Ltd.

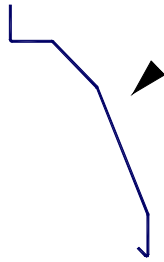

TRACK COVER
TC-01

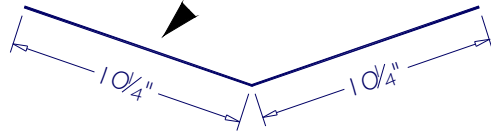

VALLEY
V-01

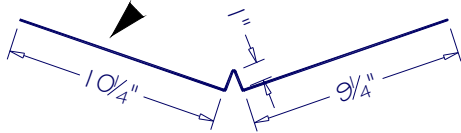

VALLEY
V-02

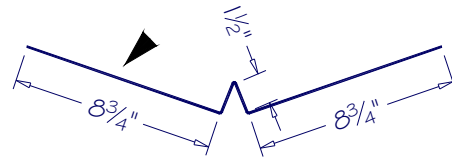

VALLEY
V-03

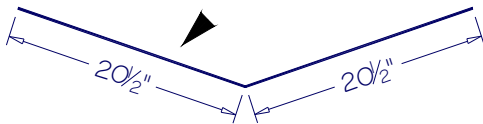

VALLEY
V-04